



**Part no.: 53800243**  
**RSL440-L/CU429-25**  
**Safety laser scanner**



Figure can vary

## Contents

- Technical data
- Dimensioned drawings
- Electrical connection
- Operation and display
- Accessories
- Notes

## Technical data

<b>Basic data</b>	
Series	RSL 400
<b>Functions</b>	
Functions	Safe time delay, internal Resolution, selectable Dynamic contactor monitoring (EDM), selectable Data output, configurable E-stop linkage Four-field mode
<b>Characteristic parameters</b>	
Type	3, IEC/EN 61496
SIL	2, IEC 61508
SILCL	2, IEC/EN 62061
Performance Level (PL)	d, EN ISO 13849-1
PFH <sub>D</sub>	9E-08 per hour
Mission time T <sub>M</sub>	20 years, EN ISO 13849-1
Category	3, EN ISO 13849
<b>Protective field data</b>	
Scanning angle	270 °
Minimum adjustable range	200 mm
Number of field pairs, reversible	Up to 100
Number of quads, reversible	50
Number of protective functions	2 Piece(s)
Number of independent sensor configurations	Up to 10
Diffuse reflection, min.	1.8 %
Operating range	0 ... 6.25 m
<b>Warning field data</b>	
Number of field pairs	Up to 100
Operating range	0 ... 20 m
Object size	150 mm x 150 mm
Diffuse reflection, min.	1.8 %
<b>Optical data</b>	
Light source	Laser, Infrared
Laser light wavelength	905 nm
Laser class	1, IEC/EN 60825-1:2007
Transmitted-signal shape	Pulsed
Repetition frequency	90 kHz
<b>Measurement data</b>	
Radial resolution	5 mm
Detection range	0 ... 50 m
Angular resolution	0.1 °
<b>Electrical data</b>	

## Part no.: 53800243 – RSL440-L/CU429-25 – Safety laser scanner

Protective circuit	Overvoltage protection
<b>Performance data</b>	
Supply voltage	24 V, DC, -30 ... 20 %
Current consumption (without load), max.	700 mA, (use power supply unit with 3 A)
Power consumption, max.	17 W, For 24 V, plus output load
<b>Outputs</b>	
Number of safety-related switching outputs (OSSDs)	4 Piece(s)
<b>Safety-related switching outputs</b>	
Type	Safety-related switching output OSSD
Switching voltage high, min.	20.8 V
Switching voltage low, max.	2 V
Voltage type	DC
<b>Safety-related switching output 1</b>	
Assignment	Connection 1, gray wire
Switching element	Transistor, PNP
<b>Safety-related switching output 2</b>	
Assignment	Connection 1, pink wire
Switching element	Transistor, PNP
<b>Safety-related switching output 3</b>	
Assignment	Connection 1, yellow/gray wire
Switching element	Transistor, PNP
<b>Safety-related switching output 4</b>	
Assignment	Connection 1, pink/green wire
Switching element	Transistor, PNP
<b>Interface</b>	
Type	Bluetooth
<b>Bluetooth</b>	
Function	Configuration/parametering
Frequency band	2,400 ... 2,483.5 MHz
Radiated transmitting power	Max. 4.5 dBm (2.82 mW), class 2
<b>Connection</b>	
Number of connections	2 Piece(s)
<b>Connection 1</b>	
Type of connection	Cable
Function	Machine interface
Cable length	25,000 mm
Sheathing material	PVC
Cable color	Black
Number of conductors	29 -wire
Wire cross section supply	1 mm <sup>2</sup>
Wire cross section signals	0.14 mm <sup>2</sup>

**Connection 2**

Type of connection	Connector
Function	Data interface
Thread size	M12
Type	Female
Material	Metal
No. of pins	4 -pin
Encoding	D-coded

**Cable properties**

Cable resistance, max.	15 Ω
------------------------	------

**Mechanical data**

Dimension (W x H x L)	140 mm x 149 mm x 140 mm
Housing material	Plastic Metal, Diecast zinc,
Lens cover material	Plastic/PC
Net weight	3,000 g
Housing color	Yellow, RAL 1021
Type of fastening	Via optional mounting device Through-hole mounting Mounting plate

**Operation and display**

Type of display	LED indicator Alphanumerical display
Number of LEDs	6 Piece(s)
Type of configuration	Software Sensor Studio
Operational controls	Software Sensor Studio

**Environmental data**

Ambient temperature, operation	0 ... 50 °C
Ambient temperature, storage	-20 ... 60 °C

**Certifications**

Degree of protection	IP 65
Protection class	III, EN 61140
Certifications	c TÜV Süd US c UL US TÜV Süd
US patents	US 2016/0086469 A US 7,696,468 B US 7,656,917 B US 8,520,221 B

**Classification**

eCl@ss 8.0	27272705
eCl@ss 9.0	27272705
ETIM 5.0	EC002550

## Dimensioned drawings

All dimensions in millimeters

Dimensions safety laser scanner with connection unit

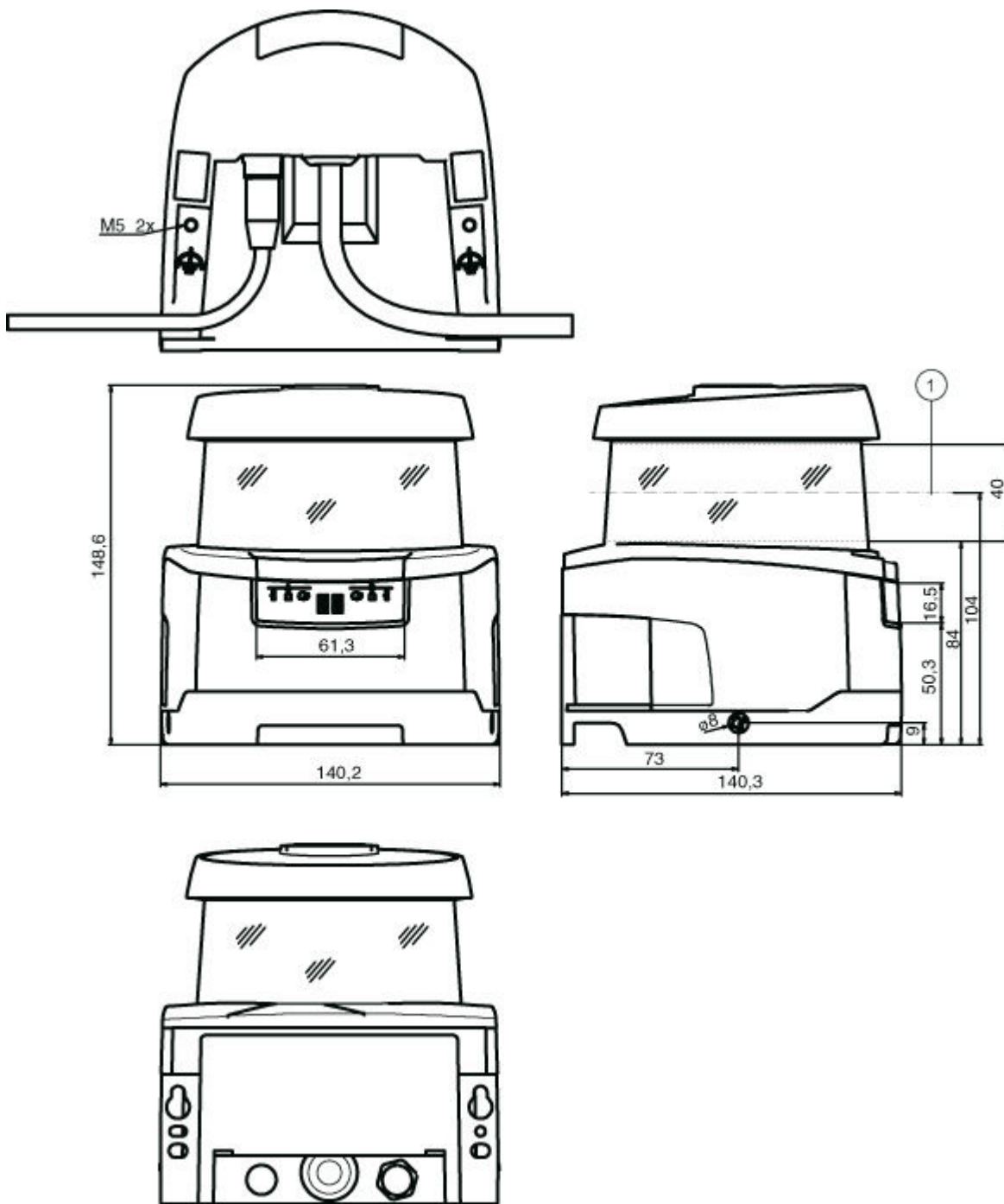

1 Scan level



### Dimensions of scanning range

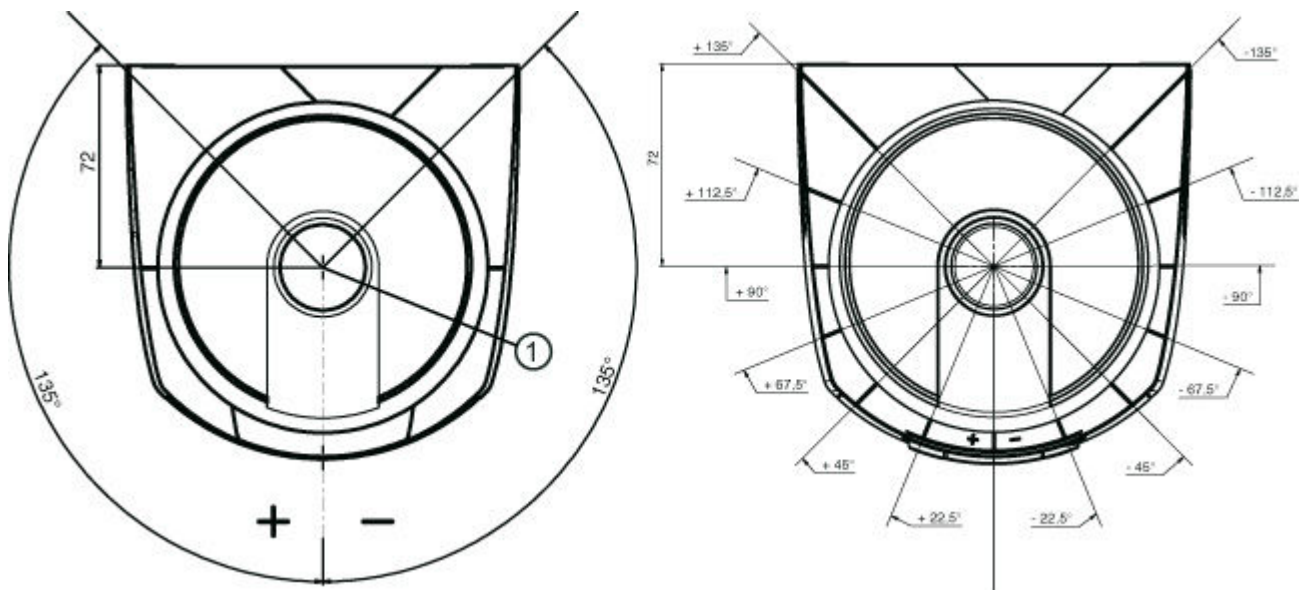

1 Reference point for distance measurement and protective field radius

### Electrical connection

Connection 1	
Type of connection	Cable
Function	Machine interface
Cable length	25,000 mm
Sheathing material	PVC
Cable color	Black
Number of conductors	29 -wire
Wire cross section	
Wire cross section supply	1 mm <sup>2</sup>
Wire cross section signals	0.14 mm <sup>2</sup>

Conductor color	Conductor assignment
White	RES1
Brown	+24V
Green	EA1
Yellow	A1
Gray	OSSDA1
Pink	OSSDA2
Blue	GND / Ground
Red	MELD
Black	F1
Violet	F2
Pink Gray	F3
Red Blue	F4
White Green	F5

Part no.: 53800243 – RSL440-L/CU429-25 – Safety laser scanner

Conductor color	Conductor assignment
Brown Green	SE1
Yellow White	SE2
Yellow Brown	A2
Gray White	A3
Brown Gray	A4
Pink White	EA2
Pink Brown	EA3
White Blue	EA4
Brown Blue	F6
Red White	F7
Brown Red	F8
Black White	F9
Black Brown	F10
Gray Green	RES2
Yellow Gray	OSSDB1
Green Pink	OSSDB2

Connection 2	
Type of connection	Connector
Function	Data interface
Thread size	M12
Type	Female
Material	Metal
No. of pins	4 -pin
Encoding	D-coded
Connector housing	FE/SHIELD

Pin	Pin assignment	Conductor color
1	TD+	Yellow
2	RD+	White
3	TD-	Orange
4	RD-	Blue
5		

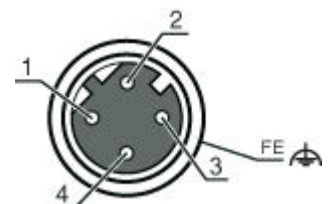

## Operation and display

### LEDs

LED	Display	Meaning
1	Off	Device switched off
	Red, continuous light	OSSD off
	Red, flashing	Error
	Green, continuous light	OSSD on
2	Off	RES deactivated or RES activated and released
	Yellow, flashing	Protective field occupied
	Yellow, continuous light	RES activated and blocked but ready to be unlocked - protective field free and linked sensor is enabled if applicable
3	Off	Free warning field
	Blue, continuous light	Warning field interrupted
4	Off	Free warning field
	Blue, continuous light	Warning field interrupted
5	Off	RES deactivated or RES activated and released
	Yellow, flashing	Protective field occupied
	Yellow, continuous light	RES activated and blocked but ready to be unlocked - protective field free and linked sensor is enabled if applicable
6	Off	Device switched off
	Red, continuous light	OSSD off
	Red, flashing	Error
	Green, continuous light	OSSD on

## Accessories

### Connection technology - Interconnection cables

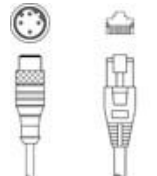
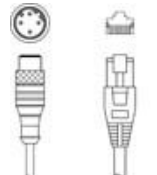
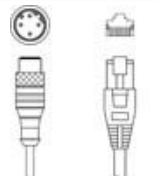
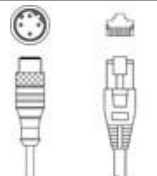
	Part no.	Designation	Article	Description
	50135080	KSS ET-M12-4A-RJ45-A-P7-020	Interconnection cable	Suitable for interface: Ethernet Connection 1: Connector, M12, Axial, Male, D-coded, 4 -pin Connection 2: RJ45 Shielded: Yes Cable, crossed: Connection 1, pin 2 <-> connection 2, pin 3 Cable length: 2,000 mm Sheathing material: PUR
	50135081	KSS ET-M12-4A-RJ45-A-P7-050	Interconnection cable	Suitable for interface: Ethernet Connection 1: Connector, M12, Axial, Male, D-coded, 4 -pin Connection 2: RJ45 Shielded: Yes Cable, crossed: Connection 1, pin 2 <-> connection 2, pin 3 Cable length: 5,000 mm Sheathing material: PUR
	50135082	KSS ET-M12-4A-RJ45-A-P7-100	Interconnection cable	Suitable for interface: Ethernet Connection 1: Connector, M12, Axial, Male, D-coded, 4 -pin Connection 2: RJ45 Shielded: Yes Cable, crossed: Connection 1, pin 2 <-> connection 2, pin 3 Cable length: 10,000 mm Sheathing material: PUR
	50135083	KSS ET-M12-4A-RJ45-A-P7-150	Interconnection cable	Suitable for interface: Ethernet Connection 1: Connector, M12, Axial, Male, D-coded, 4 -pin Connection 2: RJ45 Shielded: Yes Cable, crossed: Connection 1, pin 2 <-> connection 2, pin 3 Cable length: 15,000 mm Sheathing material: PUR



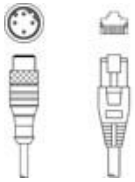

Part no.: 53800243 – RSL440-L/CU429-25 – Safety laser scanner

	Part no.	Designation	Article	Description
	50135084	KSS ET-M12-4A-RJ45-A-P7-300	Interconnection cable	Suitable for interface: Ethernet Connection 1: Connector, M12, Axial, Male, D-coded, 4 -pin Connection 2: RJ45 Shielded: Yes Cable, crossed: Connection 1, pin 2 <-> connection 2, pin 3 Cable length: 30,000 mm Sheathing material: PUR

### Connection technology - Adapters

	Part no.	Designation	Article	Description
	50134656	RSL400 M12 Adapter		Number of connections: 2 Piece(s) Connection 1: Connector, M12, D-coded, 4 -pin Connection 2: Connector, M12, D-coded, 4 -pin Dimensions: 20 mm x 90.5 mm x 40 mm Color: Black

### Mounting technology - Mounting brackets

	Part no.	Designation	Article	Description
	53800134	BT840M	Mounting bracket	Dimensions: 84.9 mm x 72 mm x 205.2 mm Color: Yellow, RAL 1021 Type of fastening, at system: Through-hole mounting Type of fastening, at device: Screw type Material: Metal
	53800135	BT856M	Mounting bracket	Dimensions: 119 mm x 72 mm x 233.5 mm Color: Yellow, RAL 1021 Type of fastening, at system: Through-hole mounting Type of fastening, at device: Screw type Material: Metal
	53800132	BTF815M	Mounting bracket	Dimensions: 186 mm x 120 mm x 288 mm Color: Yellow, RAL 1021 Type of fastening, at system: Through-hole mounting Type of fastening, at device: Screw type Material: Metal
	53800133	BTF830M	Mounting bracket	Dimensions: 186 mm x 275 mm x 288 mm Color: Yellow, RAL 1021 Type of fastening, at system: Through-hole mounting Type of fastening, at device: Screw type Material: Metal

### Mounting technology - Other



	Part no.	Designation	Article	Description
	53800130	BTU800M	Mounting system	Dimensions: 54.5 mm x 90 mm x 192 mm Color: Black Type of fastening, at system: Through-hole mounting Type of fastening, at device: Screw type Material: Metal

Part no.: 53800243 – RSL440-L/CU429-25 – Safety laser scanner

## Mounting

	Part no.	Designation	Article	Description
	53800131	BTP800M	Loop guard	Dimensions: 160 mm x 169 mm Color: Black Material: Metal

## General

	Part no.	Designation	Article	Description
	430400	RS4-clean-Set1	Cleaning set	Number of cleaning cloths: 40 Piece(s) Content of cleaning fluid: 150 ml
	430410	RS4-clean-Set2	Cleaning set	Number of cleaning cloths: 120 Piece(s) Content of cleaning fluid: 1,000 ml

## Notes

### Observe intended use!

- The product may only be put into operation by competent persons.
- Only use the product in accordance with its intended use.

### WARNING! INVISIBLE LASER RADIATION – LASER CLASS 1

The device satisfies the requirements of IEC 60825-1:2007 (EN 60825-1:2007) safety regulations for a product of **laser class 1** as well as the U.S. 21 CFR 1040.10 regulations with deviations corresponding to "Laser Notice No. 50" from June 24, 2007.

- Observe the applicable statutory and local laser protection regulations.
- The device must not be tampered with and must not be changed in any way.  
There are no user-serviceable parts inside the device.  
Repairs must only be performed by Leuze electronic GmbH + Co. KG.